



Extra Heavy Duty Manual Side Shift Flail Mower

**AGVMA 200 / 220 / 240
OPERATION MANUAL**



Ag Pro Australia Pty Ltd
3730 Harmony Way
Harcourt
Victoria 3453
1300 121 131
agpro@agproproducts.com.au

AGPRO wants to thank you for having chosen one of its products.

The technological evolution and the new request of the agricultural world have pushed our firm to a continue improvement, focused on the product, on the quality of the materials and on the quality of work.

The present manual contains the description of the machine and the necessary instructions to correctly use it, along with the instructions for an ordinary and periodic maintenance of the Flail Mower.

Such manual is subdivided in easily recognizable chapters for a practical consultation.

The indications in the present manual are addressed to a professional user, who must have specific knowledge about the driving modalities of the tractor with which the machine is connected. The user has to be authorized, instructed and opportunely trained.

We recommend you to use only original spare parts and accessories.

The use of non-original parts could be dangerous reducing the duration and the performances of the machine as well as the decay of the warranty.

In the case of doubt about the interpretation of the subjects illustrated in this handbook, we suggest you to contact the dealer who will be ready to assist you whenever you need it.

1 GENERAL INFORMATION

I.I INFORMATION ABOUT THE MANUAL

The using prescriptions shown in this Handbook must be carefully observed to obtain the best performances, to assure the greatest duration of the different parts and to avoid damages to the machine and accidents to the operator.

It is advised the careful reading of the present handbook, to deepen the knowledge of the Flail Mower, before starting to use it.

The present manual is to be considered an integral part of the machine, it must go with the machine in case of resale and till its demolition.

Some illustrations in this manual show particulars or accessories that could be different from those of your machine, some component could have been removed to assure the clearness of the illustrations.

The subjects dealt in this handbook are those expressly requested by the "CE/98/37directive" and by the relatives technical standards.

On the machine are inserted apposite pictograms, which the operator will take care to maintain in perfect visual state and to replace when they are not more readable.

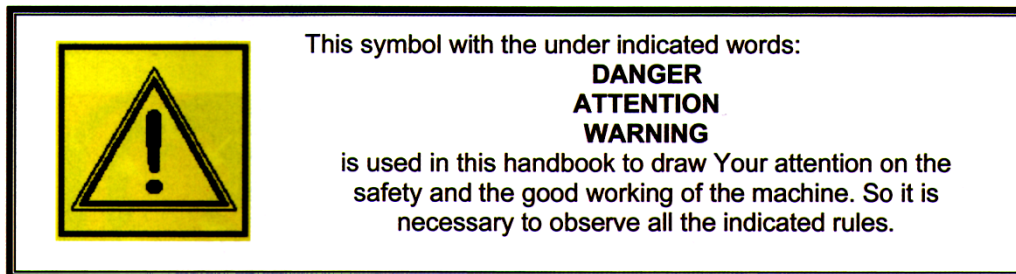

This Handbook has been written following the effective regulations at the moment of its printing. It is an integral part of the machine and must go with the machine with the Declaration of Conformity in case of resale.

1.2 IDENTIFICATION OF THE MACHINE

You will find on frame of each machine: the EC mark and a plate reporting the information about the constructor, the model and the serial number, the year of construction, the weight.

I.3 INFORMATION ABOUT THE MACHINE

Before leaving the production factory this specific model has been subjected to a severe testing to guarantee the greatest reliability.

I.3.1 Foreseen usages

The VMA model Flail Mower allows the shredding of vines, grass, straw, maize, tobacco, artichokes, mangolds, cotton and so on.

Structure consisting of a double steel type and comb counterblade and a large diameter electronically-balanced rotor mounted on sealed self-aligning bearings.

WARNING



The shredders with openable hatchback door must be used exclusively with such door (with hydraulic or manual opening) **COMPLETELY CLOSED**, the use of such door is exclusively of maintenance (we remember that for any intervention on the machine all the instruction in the chapter of this handbook reported must be observed). A use different from the one specified is considered improper.

WARNING



The machine must be used by one only operator. A use different from the one specified is considered improper.

The machine must be used exclusively by authorized, instructed and opportunely trained people.

This machine is usually used during the day, if exceptionally the night use or in condition of low visibility is requested, the lighting system of the tractor must be used.

Each arbitrary modification made to this machine, releases AGPRO any liability for damages or lesions, serious too, that could occur to the operator, third person or things.

A correct use of the machine, a scrupulous observance of the here listed rules and the strict application of all the precaution to prevent possible dangerous situations, will avoid the danger of injuries or accidents, will let work the machine better and longer and will reduce faults to the minimum.

AGPRO DECLINES ALL RESPONSIBILITIES, OBJECTIVE AND SUBJECTIVE, IF THE RULES REPORTED IN THIS MANUAL ARE NOT OBSERVED

1.3.2 Contraindications

- be sure that on the ground to work there aren't stones or rock of notable dimensions (diameter upper to 10 -15 cm);
- make sure that on the ground to work there aren't tree stumps projecting over about 10cm and of diameter upper to about 10 — 15 cm;
- make sure that on the ground to work there aren't metal elements of every kind, in particular nets, cables, ropes, chains, pipes, and so on;
- observe and apply carefully the instructions of regulation of the height of the machine from the ground, however avoid that in the range of work of the machine till 50 metres other people could stand;
- it is advised never to work "close to the ground" on wet grounds not to compromise the performance and the balancing of the machine, risking to damage the rotor too. In these cases the hoes are too much consumed, notable power is drawn from the

engine, there is the risk to HII inside the protective case of the rotor with pressed mud;

- a prolonged work "close to the ground" tends to petrify and to make the ground harder, getting its characteristics worst and compromising the good result of future cultivations.

1.3.3 Noise level

The noise testing have pointed out a Sound Pressure level LAeq equal to 84 dB(A) x 1 dB, measured in open field at a distance of 3 m. from the machine and at 1.6 m. on working land, in continuous maximum allowed working rate conditions.

According to these information it is recommended to wear an individual ear protection.

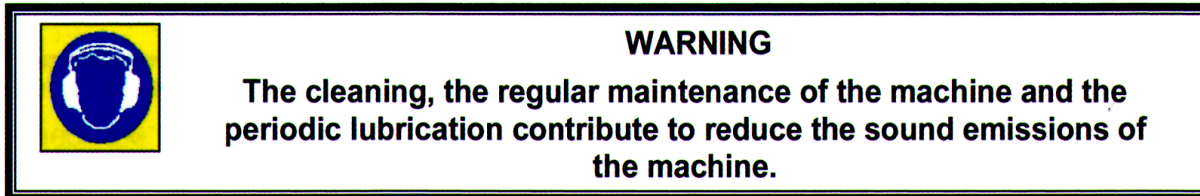

Though there is a connection between the sound emission and the exposure level, this datum can't be used to determine if it is necessary to take some precautions. In fact other factors exist that can affect the sound exposure level, such as for example the characteristics of the working environment and the presence of other noise sources. The information about the noise level emitted by the machine will however help the user or the employer in the writing of the valuation of the dangers and risks.

1.3.4 Storage

If the machine is not used for a long period it is necessary to store it in a sheltered place in order to protect it and to avoid dust accumulation. Before the storage we recommend to clean carefully the whole machine and to oil carefully the mechanic parts to protect them from the rust.

Before storing the machine for a long period, we recommend to operate as follows:

- wash carefully the machine;
- make a general sight checking of the machine to locate possible structural lesions, notice possible deep scoring on the painting, verify that the original safety pictograms are present in their right position, that they are complete and readable;
- grease all the mechanical parts, such as the tightening bolts, the joint shaft to the PTO shaft;
- recover, if possible, the machine in a covered room and lean the machine on wood boards on a flat surface;
- cover the machine with a sheet, binding it opportunely.

The used oil must not be dispersed in the environment, because, according to the effective law regulations, it is classified as special waste, and as such it must be given to the special collect centre. Please apply to the nearest Consortium of used oils.

1.3.5 Scrapping

In case of scrapping the machine should be disposed in appropriate dumps observing the effective legislation.

Before proceeding to the scrapping it is necessary to separate the plastic or rubber parts, the electric and electronic material.

Recover the possible run-down oils and dispose them in the appropriate collection centres. The parts completely made of plastic material, aluminium, steel, can be regenerated if collected in the special centres.

1.4 TECHNICAL DETAILS AND IDENTIFICATION OF THE COMPONENTS

These machines are suitable to low and medium power tractors. They are composed of a supporting frame in electric-welded steel bringing the joints for the connections to the tractor, power a power transmission system composed of an angular dismissal, a pair of pulleys connected by trapezoidal belts and by an electronically balanced rotor knives-bearing.

The models of this manual are brought by the tractor through 3 points joint, and act on the ground with their own weight and rotation of the power-taking.

By regulating the height of the lateral slides, of the wheels and of the rear roller, it is possible to vary the working height of the machine.

1.4.1 Technical details

SPECS FOR AGPRO EXTRA HEAVY DUTY MANIPAL SIDE SHIFT FLAIL MOWERS

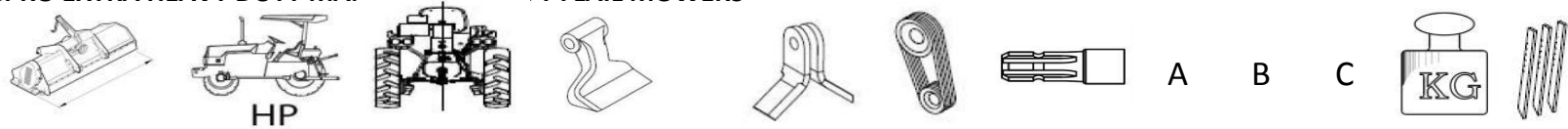

MODEL	CUTTING WIDTH	MIN	MAX	OFFSET	HAMMER BLADES	Y BLADES	BELTS	RPM	CM	CM	CM	WEIGHT	TEETH
VMA200	199	50	80	52 147 102 97	18 x 140mm	N/A	5	540	215	128	100	610	
VMA220	219	60	90	72 147 122 97	20 x 140mm	N/A	5	540	235	128	100	642	
VMA240	239	60	90	72 167 122 117	22 x 140mm	N/A	5	540	255	128	100	675	

2 SAFETY PRESCRIPTIONS

Use the machine, make the periodic checks and the maintenance intervention in conformity with what is foreseen by the effective safety regulations.

The inobservance of the regulations or basis precautions about the safety may cause accidents during the working, the maintenance and the repairing of the machine.

The Flail Mower has been produced and planed exclusively to cut grass, brushwood, prune remaining and corn trees, every other use modality must be explicitly authorized by the Company on a written document.

Any unauthorized modification on the machine excludes the company's responsibility.

WARNING



Agpro is not responsible for any possible damage caused by a not foreseen or inadequate use of the machine.

The machine must be used only by authorized, trained people, who know its potential dangers. If you have any doubt, do not hesitate to contact one of our technicians.

The instructions written in this manual must be observed carefully.

2.1 SAFETY AND ACCIDENT- PREVENTION RULES



Verify carefully the machine before to turn it on

AGPRO can't foresee all the possible circumstances which might create a potential danger. The warnings presented in this document are therefore not exhaustive

-Observe, besides the warnings in this manual container, all the general safety and accident-prevention regulations. Do not let the machine work or make the maintenance till the instructions have not been read and understood.

-The signals applied on the machine give a series of important indications: their observance is useful to your safety.

- Make sure that all the safety pictogram are readable. Clean them and eventually replace them with new labels.



WARNING

Before to begin to use the machine You need to know every devices, controls and functions, carefully read the present handbook.

- Before using the machine make sure that all the safety devices are correctly placed and in a good state; in case of breakdowns or damages to the protections replace them immediately. In particular check that the front panels are present and complete, free to swing around the bolt on which they are hinged.

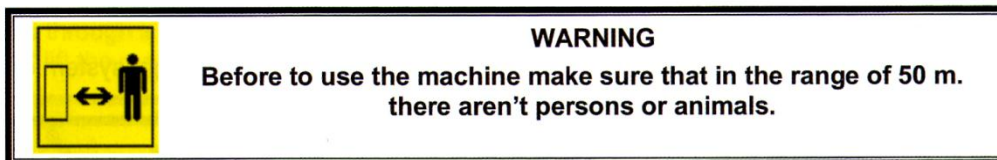
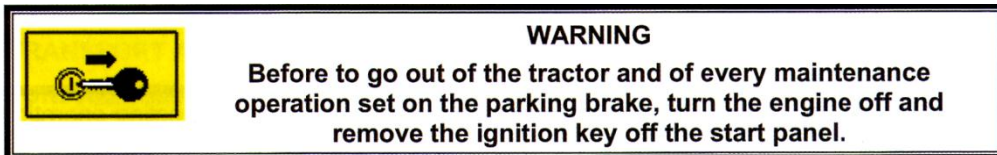

- The handbook must always be in an handing distance, allowing you to verify the operative cycle. If the book is lost or damaged you can ask for a copy
- The machine must be used exclusively by authorized, instructed and trained people.
- The machine is planed to be used by only one operator.
- Do never work with this machine if you are tired, ill or under the influence of alcohol, drugs or medicines.
- It is recommended to the operator not to wear articles of clothing that could cause catching (sleeves without closed cuffs, belts, necklaces, bracelets, rings).



- During the use the Flail Mower can give place to dust-emissions, in case of work with wet ground. It is advised to use tractors equipped with cabin with filters on the fan system or to use suitable protection systems of the respiratory tract such as anti-dust masks or masks with filter.
- Do not move the machine when the Flail Mower is working.
- The machine must not be let unguarded when started.
- Check that the machine hasn't been damaged during the transport and in this case warn AGPRO immediately
- Keep the machine clean from foreign materials (rabbles, tools, various objects) that could damage the working or the operator.



DANGER

It is absolutely forbidden to go on or to let oneself transport when the machine is in moving.

It is absolutely forbidden to go on or to let oneself transport when the machine is in motion.

- Make sure that the PTO shaft is correctly engaged after each connecting operation of the machine.
- Disconnect the machine from the tractor only on a compact and flat round, verifying that it is still and stable.
- Use the machine with enough natural light or, in alternative, use the light system of the tractor.



WARNING

Verify that the protections of the PTO shaft are complete and in good state.

- In case of breaking or deterioration of the protections of the PTO shaft, take care of their immediate replacement.

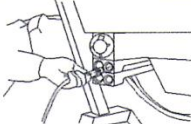

Make sure that the hydraulic pipes are connected in correct way respecting the colour recognition code and remembering that their inversion causes opposite movements to the ordered.

- Verify the wear state of the hydraulic pipes. In case of deterioration take care of their replacement. In any case replace the hydraulic pipes every 5 years.
- When the machine is not connected to the power unit, the hydraulic pipes must be connected on the special supports.



WARNING

Do not interpose oneself, for any reason, between the tractor and the shredder with the engine of and the power taking connected.



WARNING

Make sure that the shredder is completely still before to approach to the machine.

The prolonged use of the shredder can cause the heating of the gearbox, of the belt protection carter and of the elements of the hydraulic circuit. **DO NOT** touch these elements during and immediately after the use to avoid burns.



- Any changes on the machine may cause some problems. In this case the user will be the only responsible for possible accidents.

	DANGER Do not tamper, remove or make inefficient the protections and the safety devices applied to the machine for the safety of the operator and of others. The user can make exclusively the maintenance operations in this handbook described.
---	--

Use exclusively original spare parts of AGPRO

AGPRO considers itself released from each possible responsibility in the case of:

- Improper use of the Flail Mower by not trained people;
- Serious lack in the foreseen maintenance;
- Not authorized changes or interventions;
- Use of not original spare parts;
- Total or partial non-observance of the instructions;
- Non-observance of the common safety standards in the working range;
- Outstanding events

WARNING



BE SURE that the safety pictogram are readable. Clean them using a cloth, with water and soap. Replaced the damaged labels placing them in the correct position as it is described in the images below.

2.2.2 Description of the pictograms



1. WARNING The operations of regulation and maintenance must be carried out after having read the use and maintenance handbook, with the machine still and the disengaged ignition key



2. WARNING – DANGER of fluids under pressure. Read the handbook before to intervene and in case of injury address to a doctor.



3. WARNING Make sure of the rotation direction and of the number of revolutions (540 rev./min.) of the power taking of the tractor before to insert the PTO shaft.



4. WARNING – DANGER Make sure that the shredder is completely still before to approach to it.



5. WARNING – DANGER of shearing of the feet. Keep the distance.



6. WARNING Possible throw of material and/or objects, *do not stand, get through or approach to the machine.*

Keep a minimum safety distance of 70 m from the machine



7. WARNING It is forbidden to go on the machine when it is in movement.



8. WARNING Danger of catching and dragging. Do not approach the hands to the transmission shaft in motion.



9. WARNING Do not stand between the tractor and the machine.



10. **DANGER** of crash for the legs. Keep the proper distance.



11. **DANGER** of squashing / shearing of the hands.



12. **WARNING** Hot surface. Keep the proper distance



13. **WARNING** Do not remove or open the protection carters till the belts are completely still



14. **WARNING DANGER** of squashing. Do not stand in the move and side shifting zone of the machine.



15. **WARNING:** for the lifting, hook the machine exclusively in the indicated points.



16. Use the requested Individual Protection Devices.



17. Greasing points (see par. 6.4)

3 TRANSPORT AND INSTALLATION

3.1 UNPACKING AND POSITIONING

Take the maximum care to the safety during the loading and unloading operations, that shall be performed by qualified personnel (slingers, truck operators, and so on).

For the transport the machine must be positioned on pallets, fixed with suitable belts, and moved through a loader with a fit lifting ability.

Do not lift the machine with belts.



For the lifting of the machine use safety hooks or cables of suitable ability to insert in the preset eyebolts for the lifting indicated by the pictograms applied on the machine.

3.2 CHECK OF THE LIFTING CAPABILITY AND OF THE STABILITY OF THE TRACTOR

Verify the lifting capability and the stability of the tractor through the following formula and if necessary apply frontally the ballasts.

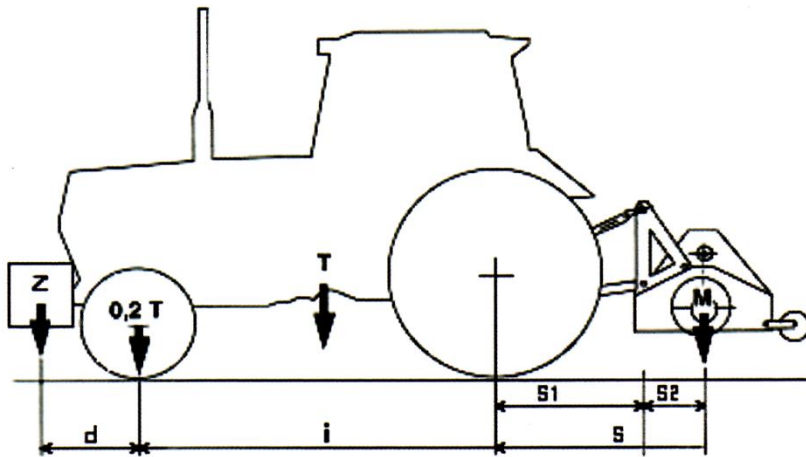

$$M \times s \leq 0,2 T \times i + Z (d + i)$$

$$M < 0,3 T$$

i	=	axle base wheels tractor
d	=	distance of the front axle from the ballasts
S	=	overhang of the rear axle of the operator machine S = S1 + S2
S1	=	distance of the tractor front axle to the end lifting arms
S2	=	distance of the shredder barycentre to the centre holes lifting pins
T	=	mass of the tractor + 75 kg (operator)
Z	=	Mass of the ballasts
M	=	mass of the whole loaded machine



DANGER!

It is obligatory to verify the lifting ability and the stability of the tractor to avoid its turnover and/or loss of adhesion of the steering wheels.

4 CONNECTION TO THE TRACTOR

The behaviour on the road, the steer and brake capacity are influenced by the used tools. The front axle of the tractor is lightened in relationship to the weight attached at the moment of the coupling to the lifting arm: the loading of the front axle must be at least 20% of the weight of the empty tractor.

Before the connection of the machine to the 3 points joint, position the safety device of the tractor to make impossible the unwanted and/or casual lifting and lowering.

The 3 points joint of the tractor and of the machine must coincide or be adapted.

In the rods zone of the rear lifting arms of the tractor there is the danger of injury owing to squashing and cutting points.

Do not use the outside control for the lifting of the machine.

In the transport position block the side halt of the rods and the control level of the lifting.

4.1 CONNECTIONS

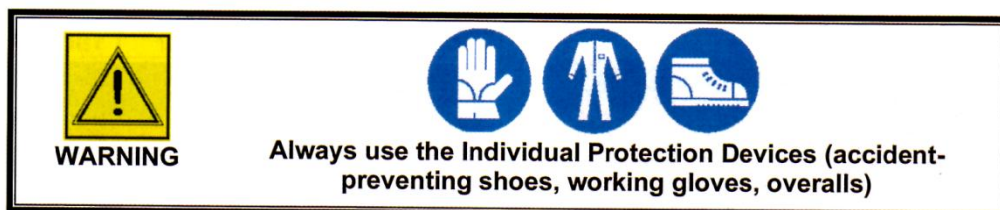

4.1.1 Assembly of the Flail Mower and regulations

The machine is equipped with bolts for the 3 points joint of the tractor.

For the connection of the structure of the machine to the tractor operate as follows:

- Approach the tractor to let the lifter bars coincide with the 3 points joint and connect them through the bolts on issue.

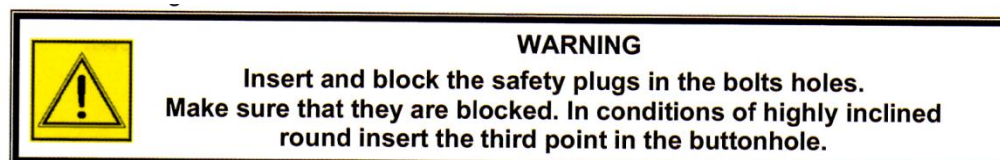

-Connect the third point to the upper joint and regulate it to position the machine in a parallel way to the ground. Verify that the knives or the hammers of the rotor shaft, when the machine is to the round, don't touch the round during the rotation. In the versions equipped with slides verify that these lean on the round along its whole surface.

To avoid that the knives or the hammers go into the ground it is necessary to regulate the height of the rear roller lightening the blocking screw and inserting it in the chosen hole.

- Lift the machine and acting on the rods of the lifter bars block the movement.



WARNING

Position the tractor in a flat zone to avoid the side charge of the machine on the rods. Before to perform the regulation halt the engine and block the brakes.

4.1.2 Connection to the PTO shaft

After having executed these operations you can connect the transmission PTO shaft of the power taking to the grooved shaft of the gearbox of the machine (covered by a protection counter guard) and then to the power taking of the tractor:

- clean and grease the power taking;
- grease, if necessary, the PTO shaft following the indications given by the producer of the PTO shaft (see Use and Maintenance Handbook of the PTO shaft):
- clutch the PTO shaft observing the mounting sense prescribed by the producer and indicated on the outside covering of the protection.
- Hitch the anti-rotation chain.
- Make sure that the anti-withdraw safety block (push button) is correctly inserted and blocked in its own housing.



WARNING

**Verify that the speed regulation of the power taking of the tractor is on a value of 540 rev/min.
The PTO shaft must be always connected at last to the power taking of the tractor and disengaged at first at the end of the working.**

When disengaged, the PTO shaft, must be connected to the apposite support.
For a correct and sure working of the machine use exclusively PTO shaft with EC mark.
The length of the PTO shaft must be suitable to the kind of tractor that is used.

AGPRO is not responsible for any damages caused by a non correct use of the cardan transmission

4.1 .3 Hydraulic connections for lateral shifting

Switch the engine off (if on), set the handbrake on and remove the ignition key off the start panel

Verify that there isn't pressure in the hydraulic system of the tractor.

Connect the hydraulic pipes with rapid clutch to the tractor after having checked that all the joints are clean and in very good preservation state.

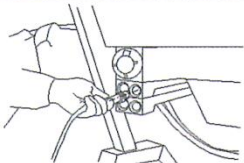

Make sure that the hydraulic pipes are connected in correct way respecting the colour recognition code and remembering that their inversion causes opposite movements to the ordered.

Give pressure to the hydraulic system, verify that there aren't drippings and that the connection is correct.



As the shredding operations are finished, the hydraulic pipes released from the tractor must be fixed in the apposite supports for this purpose foreseen.



WARNING
Before to connect/disengage the hydraulic pipes stop the engine of the tractor and set on in both senses the control levels to let the oil flow from the system.

Before connecting, turn the hydraulic pipes off, stop the engine of the tractor and set on in both senses the control levels to let the oil flow from the system.

5. USE OF THE MACHINE

ATTENZIONE

Always use the Individual Protection Devices (accident-preventing shoes, working gloves, overalls, goggles and anti-noise ear guard)



WARNING
Before to use the machine make sure that in the range of 50 m. there aren't persons or animals.

Before starting to work you need to regulate the machine to obtain a good working trim (see "Assembly and regulation", par. 4.1.1).



Before to go out of the tractor and of every maintenance operation set on the parking brake, turn the engine off and remove the ignition key off the start panel and wait the stop of all the mobile elements.

For a very good work we recommend to proceed to an advancement speed of 2,5 km/h on grass round and of 2,0 km/h on pruning residual.

During the work do not take curves with the machine to the ground, nor work in reverse.

Always lift the Flail Mower for the direction changes and the curves, inserting first the power taking.

During the use the Flail Mower can give place to dusts emissions, in that case you are working with a dry ground. We recommend to use tractors equipped with cabin with filters on the fan system or, to use suitable system for the protection of the respiratory tract such as anti-dust masks or masks with filter.

6 MAINTENANCE



In case of breakdown the operator must stop immediately the power taking, remove the ignition key, go out of the tractor to make sure of the entity of the problem and proceed with possible interventions on the machine.

It is advised that all the maintenance operations must be performed by qualified and trained people, with the machine still and disengaged from the tractor.

It is necessary to verify daily the wear state of the knives, of the hammers and their connecting points, replacing immediately the ones that are worn or damaged because their breaking may cause dangerous projections of components.

6.1 ROTOR

The rotor shaft has been preliminarily balanced: in case of replacement of a tool, it is advisable to replace all the series. To assemble not original tools can cause vibrations of the machines or breaking of the rolling bearings.

The replacement of the damaged parts must be performed exclusively by specialized people.

For the knives replacement interventions it is necessary to apply to specialized people making use of the assistance service by AGPRO or its dealers.

6.2 FRONT PROTECTION BARS

The protection bars must always be in good state to avoid possible throw of materials in the front zone.

Immediately replace such parts even if they're lightly bended or worn.

For the bars replacement it is necessary:

- To unscrew the fixing screw of the bolt on the left side of the machine and withdraw the fixing bolt
- Replace the damaged bars
- Take care of the clamping of the fixing screw of the bolt.

Use exclusively original spare parts

6.3 ORDINARY MAINTENANCE

- Perform the maintenance with the machine disconnected by the tractor and opportunely positioned.
- Any maintenance work, regulation and cleaning must be performed with the machine to the ground, the engine of the tractor turn off, power taking disengaged, handbrake set on, ignition key disengaged and removed from the start panel
- Each 4 hours of work check the tension of the belts, You must always must care about their regulation



Perform this regulation only with the tractor turn off and power taking disengaged, remove the ignition key, wait until all the mechanisms are stopped.

6.3.1 Regulation of the belts

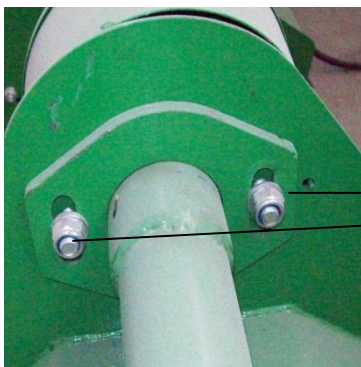

Loosen the screw **A** and **B** that block the support shaft
And loosen the counter nut **C**

Loosen the screws that block the gearbox on the support shaft **D**



**6.3.2
AND**

LUBRIFICATION

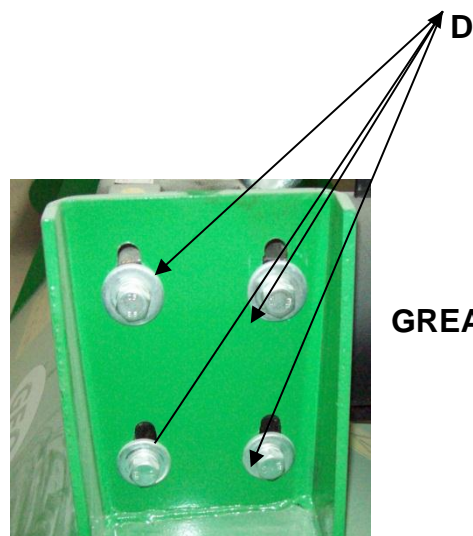

GREASING

Each **4 hours** of work:

- Verify camping of the nuts
- Grease with lithium oil when it is indicated by the symbol **GREASE**



After 50 hr of work:

-verify the right amount of oil in the transmission unit and restore it till a good level, using oil type 80W90 Mineral Oil

Each 100hr of work:

-verify the right amount of oil in the transmission unit and restore it till a good level

6.4 INCONVENIENCES AND REMEDIES

INCONVENIENCES	CAUSE	REMEDY
Clogging of hammers/knives	Rotor speed is too low	Increase rotor speed
Excessive wear of hammers/knives	Rotor speed is too high	Decrease rotor speed
Flail Mower vibrates during works	<ul style="list-style-type: none"> • Foreign matter stuck in between • hammers/knives broken • Bolts of the rotor shaft support have come lose 	<ul style="list-style-type: none"> • Remove foreign matter • Replace hammers • Lock bolts

7 WARRANTY CONDITIONS

7.1 DURATION OF THE WARRANTY PERIOD

The manufacturer warrants all its products as free of defects in material and in workmanship for one year from the date of delivery of the machine.

7.2 WARRANTY CONDITIONS

- 1) the commitment of this warranty is limited only to the replacement and/or repair of those elements considered to be defected in material or workmanship after an inspection of our technician;
- 2) the damaged elements must be in unaltered conditions, not disassembled by unauthorised persons and furthermore must not have been subject to bad use, negligence or accidents;
- 3) labour and transport fees for the repair or replacement of defected parts are excluded from this warranty;
- 4) no warranty performed by someone other than the manufacturer shall be considered valid or binding;

- 5) the manufacturer holds the right to perform modifications without prior notice and whenever modifications take place the manufacturer shall not be obliged to carry out these modifications on products manufactured previously;
- 6) upon delivery check that the machine was not damaged during transport and that it is complete in every part. Claims must be presented by writing within 8 days from the date of delivery of the machine.

7.3 DECAY

The warranty does not cover the customer when :

- 1) The damage is due to a manoeuvre error;
- 2) The damage is due to repairs made by unauthorised people or using non original spare parts
- 3) The instructions written in this manual are not followed.

7.4 WARRANTY CERTIFICATE

Dear Customer,

We thank you and we congratulate you for having chosen an AGPRO product

Our brand is a guarantee of quality and avails of a wide net of dealers who are able to intervene and resolve any problem connected with the product that you have purchased.

The warranty validity conditions are already mentioned in the previous pages of this manual.

WARRANTY COUPON NUMBER:

MACHINE TYPE:

- **Model**.....
-
- **year of construction**.....
-
- **serial number**.....
-
- **manufacturer**.....

Extra Heavy Duty Manual Side Shift Flail Mower Assembly

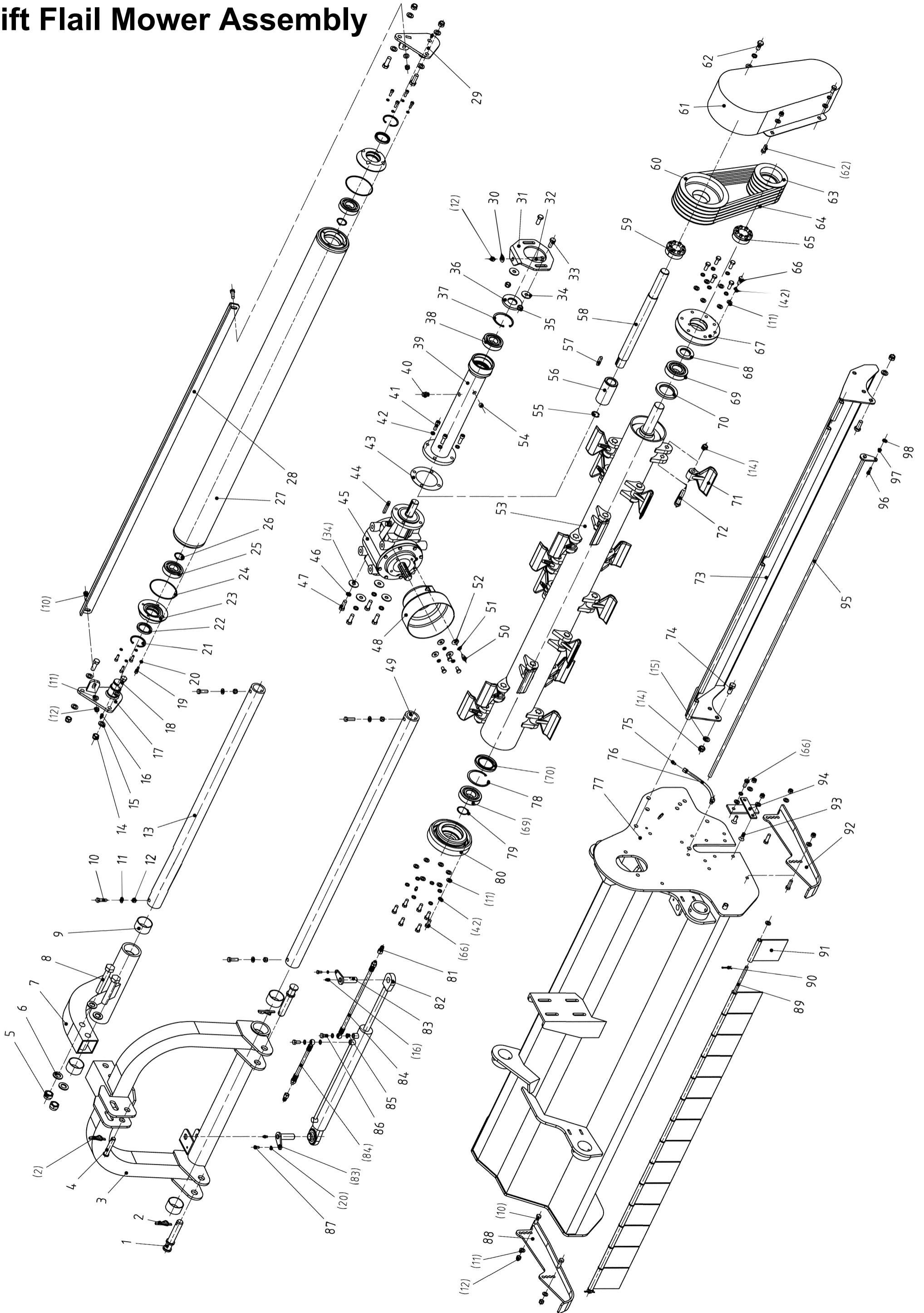

Extra Heavy Duty Manual Side Shift Flail Mower Parts List

Part	Code	Name	Quantity
1	RMC200.109	Lower Suspension Pin	2
2		Lock pin	3
3	VM190.011	Rear hang weldment	1
4	IG180.117	Upper suspension pin	1
5	DIN985	Lock Nut M24	2
6	GB97.1-85	Washer 24	4
7	VMA200.012	Hang connect pipe	1
8	GB5782-86	Bolts M24 x 140	2
9	SF-2	Bearing 65 x 70 x 40	4
10	GB5783-86	Bolts M12 x 40	10
11	GB97.1-85	Washer 12	54
12	DIN985	Lock Nut M12	16
13	VM190.117	Guide Shaft	1
14	DIN985	Lock Nut M16	26
15	GB97.1-85	Washer 16	12
16	GB1152-89	Nipple M6	5
17	RMC200.027	Right Roller Connection Plate	1
18	GB5783-86	Bolts M16 x 45	4
19	GB70-85	Bolts M8 x 25	8
20	GB93-87	Washer 8	10
21	GB893.1-86	Circle 65	2
22	GB13871-94	Oil Seal 50 x 68 x 8	2
23	RMC200.117	Roller Cover	2
24	GB3452.1-82	O ring 120 x 3.55	2
25	GB/T276-94	Bearing 6308	2
26	GB894.1-86	Circle 40	2
27	RMC200.028	Roller Weldment	1
28	VM190.101	Scraper	1
29	RMC200.030	Left Roller Connection Plate	1
30	GB96-85	Large Washer 12	1
31	VM190.114	Tension Plate	1
32	GB5783-86	Bolts M12 x 70	1
33	GB5783-86	Bolts M14 x 35	2
34	GB96-85	Large washer 14	6
35	DIN985	Lock Nut M14	2
36	GB13871-94	Oil Seal 40 x 90 x 10	1
37	GB893.1-86	Circle 90	1
38	GB/T278-94	Bearing 6308ZZ	1
39	VM190.022	Transmission Shaft Tube	1
40		Plug ZG3/8	1
41	GB70-85	Bolt M12 x 35	4
42	GB93-87	Washer 12	18
43	VM190.110	Paper Washer	1
44	GB1096-79	Key A10 x 70	1
45	XH75.2837.02W	Gear Box	1
46	GB93-87	Washer 14	4

Extra Heavy Duty Manual Side Shift Flail Mower Parts List

Part	Code	Name	Quantity
47	GB5783-86	Bolts M14 x 40	4
48	VM190.109	PTO Cover	1
49	VM190.118	Guide Shaft	1
50	GB5783-86	Bolts M10 x 20	4
51	GB93-87	Washer 10	4
52	GB96-85	Large Washer 10	4
53	VM190.019	Hammer Rotor	1
54	ZBT32001.3-87	Bolt M8 x 25	1
55	GB893.1-86	Circle 33	1
56	VM190.116	Connecting Sleeve	1
57	GB1096-79	Key A12 x 50	1
58	VM190.115	Transmission Shaft	1
59	JB/T7934Z3	Reach 40 x 50	1
60	VM190.113	Bigger Pulley	1
61	VMA200.013	Pulley Cover Weldment	1
62	GB5783-86	Bolts M12 x 25	3
63	VM190.112	Small Pulley	1
64	GB/T1154-97	Belts 17 x 1300	5
65	JB/T7934Z3	Reach 45 x 80	1
66	GB5783-86	Bolts M12 x 30	14
67	VM190.111	Right Bearing Seat	1
68	GB13871-94	Oil Seal 4580 x 8	1
69	GB/T281-94	Bearing 1309	2
70	GB13871-94	Oil Seal 65 x 100 x 10	2
71	RMC200.111	Hammer	20
72	GB5782-86	Bolts M16 x 90	20
73	VMA200.017	Rear Bonnet weldment	1
74	GB5783-86	Bolts M16 x 40	2
75	GB1152-89	Nipple M10 x 1	1
76	RMC200.015	Grease Pipe	1
77	VMA200.014	Hook Cover Weldment	1
78	GB893.1-86	Circle 100	1
79	GB894.1-86	Circle 45	1
80	VM190.106	Left Bear Seat	1
81		Quick Change Connector	2
82	VM190.024	Side Shift Cylinder	1
83	RSC125.103	Lock Pin	2
84	VM190.025	Oil Pipe	2
85	GB3451-83	Copper washer 12	4
86	GB3451-83	Bolts M12 x 1.25	2
87	GB5783-86	Bolts M8 x 16	2
88	RMC200.012	Left Side Plate	1
89	RMC200.102	Baffle Plates Rod	1
90	GB91-86	Cotter Pin 4 x 32	2
91	RMC200.103	Fender	15
92	RMC200.013	Right Side Plate	1

Extra Heavy Duty Manual Side Shift Flail Mower Parts List

Part	Code	Name	Quantity
93	GB/T70.3-2008	Bolts M12 x 35	2
94	VMA200.015	Notch Baffle	1
95	VMA200.016	Hang Pipe weldment	1
96	GB5783-86	Bolts M8 x 30	1
97	GB97.1-85	Washer 8	2
98	DIN985	Lock Nut M8	1