



ATV FLAIL MOWER

Briggs & Stratton Engine

OPERATION MANUAL



Ag Pro Australia Pty Ltd
3730 Harmony Way
Harcourt
Victoria 3453
1300 121 131
agpro@agproproducts.com.au

INDEX			
Section:		Description:	Page No:
	1	Introduction	2
		HSE information sheet	3
	2	In the interest of safety: DO NOT	5
	3	In the interest of safety: DO	5
	4	Instruction & Warning Decals	6
	5	Operating Instructions And Adjustments	7
		5.1 Initial Check	7
		5.2 Drawbar Adjustment	8
		5.3 Mower Cutting Height	9
		5.4 Starting The Engine	9
		5.5 Forward Speed	10
		5.6 Stopping The Mower	10
		5.7 Transport Position	10
		5.8 Anti-scalping roller / Side skid' s	11
	6	Maintenance Schedule	12
		6.1 Engine	12
		6.2 Excess Crop Build Up	12
		6.3 Visual Check	12
		6.4 Tyre Pressures	13
		6.5 Rotor Bearing Inspection	13
		6.6 Wheel Bearing Inspection	13
		6.7 Oil Coupling / Bush Wear	13
		6.8 General Inspection	13
		6.9 Rotor Flail Maintenance	13
	7	Parts List	15

With the purchase of your FLAIL MOWER you have made an excellent choice.

This machine should give first class service for a long time, if used correctly, and maintained as described in this manual.

Fitted with an easy to start engine it has been designed to cope with a wide range of conditions. The ATV Flail mower incorporates easy height adjustment, range of engine options and a full width anti-scalping roller to avoid damage to machine and sward.

The mower is constructed from 4mm steel for added strength; all fittings are of high quality to ensure years of trouble free use.

Different wheel options are available for the ATV Flail Mower

Selecting and using equipment for all terrain vehicles (ATVs)

Introduction

This information sheet gives advice to users on how to use all Terrain vehicles (ATVs) safely with towed and mounted equipment.

Plan the use of an ATV carefully and take particular note of ground conditions and slopes, as these may vary considerably, depending on the terrain, weather conditions, ground surface and the crop under the wheels.

Towed equipment

Choose equipment which matches your ATV. Stability of towed equipment is affected by:

Weight ratios

1. The safe ratio between the trailed laden maximum weight and unladen weight of the ATV must be assessed for each operation.
2. Always take note of information given in the manufacturer's handbook when making this assessment.
3. As a guide research shows that on level ground, 4 x unladen weight of the ATV for braked trailed equipment and 2 x unladen weight of the ATV for unbraked trailed equipment are the appropriate maximum ratios.

Note: For work on slopes or uneven ground the ratio will need to be reduced.

Braking

Fit:

1. Brakes to trailed equipment. This helps prevent jack-knifing when braking or traveling downhill;
2. Over-run brakes which come into action whenever the ATV brakes are applied;
3. A manually operated parking brake operable from the driving position. This provides control for use when going up slopes.

Hitching and loads

Stability is also improved if:

1. Some weight is transferred from the trailer onto the ATV draw-bar;
2. The draw-bar has a swivel hitch and the ATV a ball hitch having a large head to neck ratio. This makes it easier for the draw-bar hitch to swivel and cope with undulating ground;
3. The load is positioned as near to the centre of the trailer as possible.

Tyres and wheels

1. Check tyre pressures regularly with a pressure gauge capable of reading low pressures accurately;
2. Check tyres regularly for damage and wear;
3. Select equipment which has tyres and wheels that can cope with speeds over 20mph and occasional higher speeds;
4. Use wheels with bead locks on the rims if the main use is going to be on sloping ground. This prevents tyre run-off on side slopes.

Maximum towed weight

Follow the advice given by manufacturers on the maximum trailed weight. This will be found

on the equipment or in the instruction handbook.

Note: Universal road going trailers will normally have the maximum gross weight stated on a separate notice.

Mounted equipment

ATVs using mounted equipment are safer if the equipment has:

- a low centre of gravity .This improves stability.
- a gross weight within the limits approved by ATV manufacturer.
- no dangerous projections to injure the operator or bystanders;
- no forward projections which stop head protection being worn;
- controls which are easy to work and which do not creat a hazard to the operator;

Instructions for mounted and trailed equipment

Take note of the manufacturer's instructions on:

- operating on slopes;
- where to place loads so as to give fore/aft and lateral stability;
- the risks of using equipment with negative drawbar nose weight, ie loss of traction;
- the maximum operating speed;
- the effect that equipment carried on front and/or rear racks will hace on longitudinal and lateral stability;
- securing loads;
- the use of ballast, if any ,to improve stability;
- the need to select and use safe routes.

Using an ATV

- read the manufacturer's instruction book and take note of the safety advice given;
- Choose an ATV with enough power for the work you want it to do .four-wheel driver will give better traction and mobility and may provide a margin of safety;
- Choose a safe route;
- Be aware that increased speed greatly increases the risk of instability and the risk of an overturn;

Training

Train everyone who has to use an ATV whether with mounted or trailed equipment or as a solo machine. The training should emphasise the factoes affecting stability, the need for care and concentration, and how to recognise the conditions which may affect the safety of operation,It is important for trainees to familiarize themselves with the handing and control of the machine on level open ground before tackling rough hill terrain. Suitable training courses are run by bodies such as ATB Landbase and the forestry Authority.

Helmets

Wear head protection which protects the head and neck. Helmets are suitable. Some users find open faced helmets more suitable than full face helmets.



This symbol means WARNING or CAUTION Personal safety or damage will be at risk if these instructions are ignored. Most accidents are caused by neglect or carelessness; Avoid needless accidents by following the safety precautions listed below.

2

IN THE INTEREST OF SAFETY:DO NOT

1. DO NOT - Operate the mower without all the correct guards fitted.
2. DO NOT - Alter engine settings unless stated by Engine manufacturer.
3. DO NOT - Touch any moving or rotating parts, during working conditions
4. DO NOT - Stop the engine immediately after heavy use, (See section 5.6)
5. DO NOT - Operate the mower without suitable ear and eye protection
6. DO NOT - Allow passengers.
7. DO NOT - Leave machine un-attended while operating
8. DO NOT - Run the engine in an enclosed area, exhaust gases contain Carbon Monoxide and are fatal if inhaled.
9. DO NOT - Operate the mower on excessively steep slopes.
10. DO NOT - Operate the mower unless all safety features are fitted to the mower and are used correctly
11. DO NOT - Operate the mower until you have read and understood the entire operators manual
12. DO NOT - Wear loose fitting clothing, to avoid catching on parts of the machine
13. DO NOT - Try to remove blockages while the engine is running. Ensure engine is stopped and the rotor has finished rotating, before any servicing takes place to your mower.
14. DO NOT - Operate the mower in Dark conditions unless suitable artificial light is used.
15. DO NOT - Operate if excessive vibration occurs, stop the machine immediately and view maintenance chart.
16. DO NOT - Climb on the mower.

3

IN THE INTEREST OF SAFETY:DO

1. DO - Follow Engine manufactures guideline.
2. DO - Ensure all spectators are a safe distance away when operating.
3. DO - Carry out regular servicing and checks before use.
4. DO - Clear cutting area from potential damaging components.
5. DO - Reduce speeds when working on hillsides or rough terrain
6. DO - Be aware components can be hot after operation
7. DO - Follow any towing guidelines stated by ATV manufacturer.
8. DO - Show some caution when filling the tank with petrol, especially if engine components are hot.
9. DO - Ensure all safety decals are in good condition, replace any that are damaged.
10. DO - Keep hands and feet away from rotating blades
11. DO - Ensure mower is in transport position before transporting from workplace.

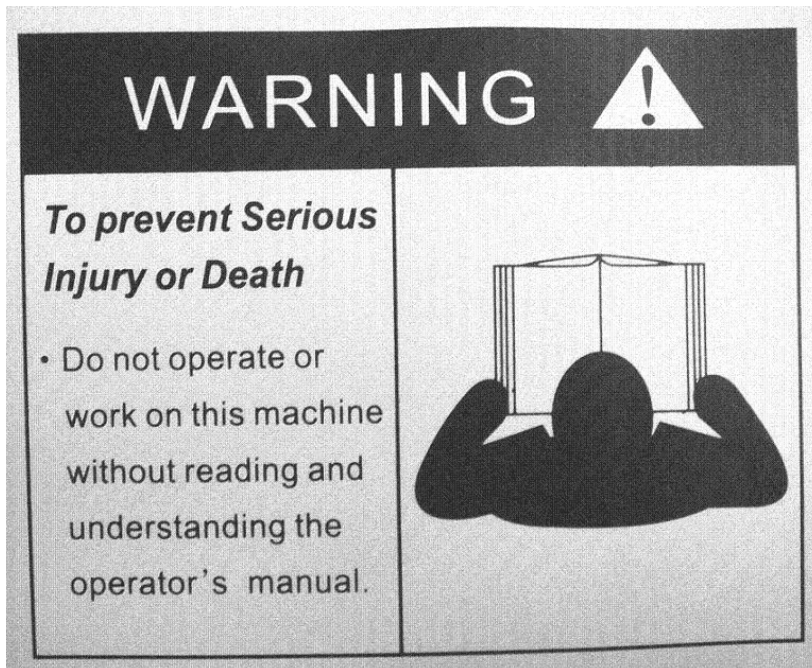

KEEP WHEEL NUTS TIGHT

CHECK DAILY

REFER TO THE OPERATORS MANUAL

FOR CORRECT TYRE INFLATION PRESSURE

OBSERVE TOWING VEHICLE MAX TOWING LIMITS OR TRAILER MAX WEIGHTS

ATTENTION

Your responsibilities before operating this machine are:

- . Read Understand and Follow the safety procedures manual
- . Train operators before using & review safety procedures regularly
- . Ensure that all guards are in place before operating
- . Keep Hand, Feet, Hair and Clothing away from all moving parts
- . Avoid wearing loose clothing whenever possible
- . Maintain as per schedule in the safety procedures. Especially Blades and Securing Hardware, due to the hazard they present should any part break loose during operation
- . During maintenance, use suitable support stands
- . DO NOT allow any persons to ride on the equipment

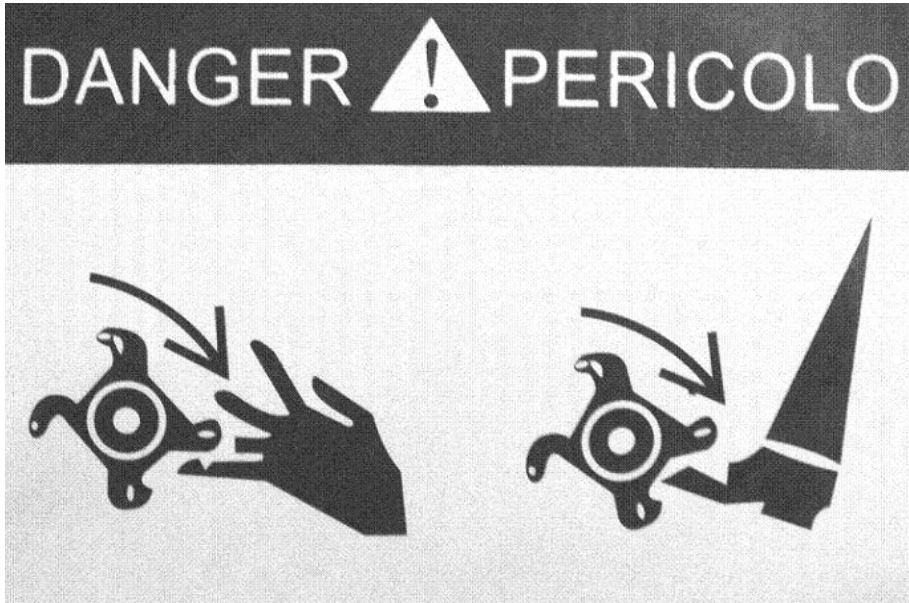

The above decals should be located on your AT - Flail Mower. If any of the above decals are not located on your AT or are damaged in any way contact for some replacement decals before use.

5

OPERATING INSTRUCTIONS AND ADJUSTMENIS

The ATV Flail Mower is designed to give safe and dependable service if operated according to instructions and intended use.

Read and understand this manual before operating the mower, as failure to do so could result in personal injury or equipment damage.



When used with an A. T. V or compact tractor, ear defenders should be worn. Under normal working conditions a noise level of 83 decibels would be usual, in this case protection is advised.

5.1 INITIAL CHECK

1. Make sure that all nuts, bolts and fittings are securely fixed, and that all packaging materials e.g. wire bands, tape etc have been removed. (Remove tape from the front stone deflectors from the underside of the body)

2. Check the there is oil in the engine and petrol in the tank.
3. Check tyre pressures.

5.2 DRAWBAR ADJUSTMENT

The drawbar attachment height of the towing vehicle can vary. To accommodate adjustment, a screw link is located beneath the drawbar. This should be lengthened or shortened so that the cutting deck is horizontal to level ground. (This ensures a better cutting efficiency)

TO ADJUST

1. Unlock the locking nut (A)
2. Lengthen the link to lower the front of the deck or shorten to raise the deck.
3. Once the deck is level, re-tighten locking nut (A).

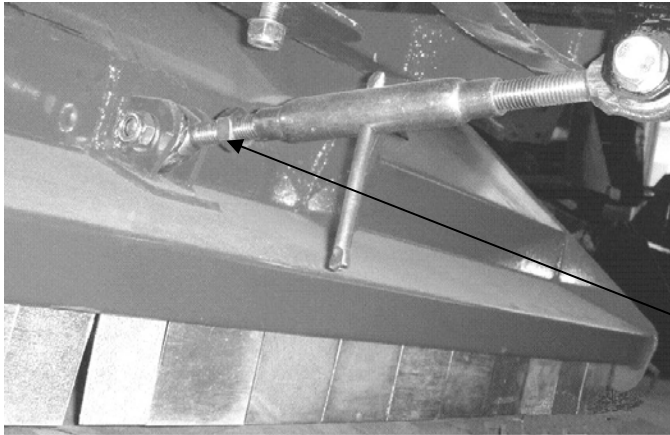

A

QUICK OFFSET DRAWBAR

Pull back the locking pin; slide the drawbar to the desired position, and release the locking pin into the securing hole, as shown.

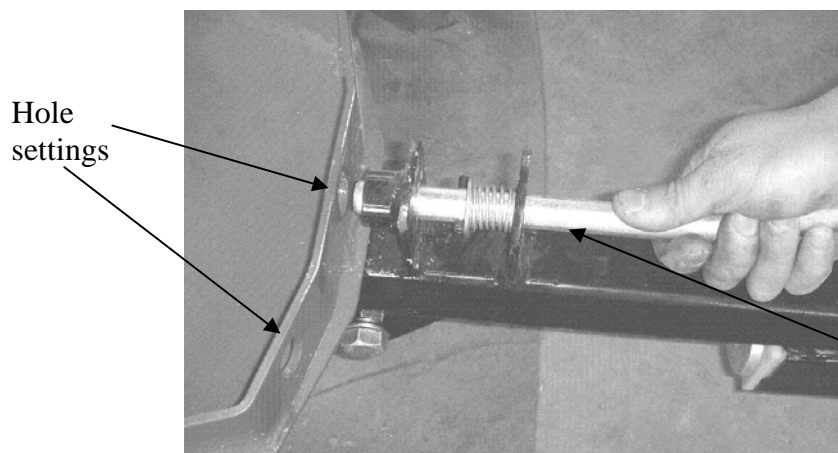

Hole
settings

Locking
pin

5.3 MOWER CUTTING HEIGHT

The main cutting height adjustment is achieved by using the screw jack, to raise or lower the cutting deck as necessary.

CUTTING HEIGHT ADJUSTMENT:

Turn the handle to raise or lower as necessary.



5.4 STARTING THE ENGINE

READ AND UNDERSTAND THE ENGINE OPERATORS MANUAL BEFORE USE



Observe all safety precautions; keep hands and feet away from rotor and other moving parts. Keep spectators at a safe distance.

1. Make sure there is a gap between the blades and the ground / crop
2. Select an area clear of loose debris that could be picked up.
3. Set the engine choke, and suitable idling speed with the throttle.
4. Place one foot on top of the deck body to give a firm and balanced position. Pull the starter cord firmly, allowing the cord to return to return to the housing slowly (one or two strong pulls should start the engine).
5. After a few seconds warming up at idling speed, move the throttle to the factory pre-set working position to give a normal/working engine R.P.M of 3600 max.

NOTE



If the throttle is altered to increase the engine R. P. M beyond the recommended level, the guarantee may become invalid. In addition to this, cutting efficiency will be reduced, fuel consumption will increase and excessive vibration could be caused, resulting in a potential danger to personnel and damage to components.

ELECTRIC START

Push button electric start engine options can be supplied if required. Simply hitch up the mower, connect the electrical supply plug to the ATV socket and turn the ignition key to start the mover. Observing all the precautions mentioned above in 'Starting the mower' .

REMOTE THROTTLE CONTROL

When a remote throttle control option is fitted, normally to the rear carrier frame

of an ATV or other suitable site on the towing vehicle, it gives the operator the facility of controlling the mower engine from the operating position.

The facility is most beneficial when moving from one cutting site to another close to it, by reducing the engine revs to allow the mower flails to come to rest, no harm will be caused to the mower or ground surface during transport, often over rough or difficult terrain when stones and loose objects may be encountered.

5.5 FORWARD SPEED

The amount of grass or weeds to be cut dictates the forward speed; slow forward speeds give better results in most cases. Ensure you follow the procedure below.

NORMAL FORWARD SPEED (1 kph - very heavy use - 10 kph - very light use)

Start off in the slowest speed possible, ensure the mower is working efficiently with the engine set at maximum RPM and not labouring. (If this is not possible due to very heavy cutting conditions, raise cutting height of blades and be prepared to go over twice with machine set lower on 2nd pass, leave at least 24 hours in between 1st and 2nd cut to allow grass to dry out)

Increase forward speed until the RPM of the engine starts to slow down (This is working the engine too hard for conditions) - slow down, let the engine regain full RPM and go through the same process but stop short of speed which made engine labour previously. It is important always to listen to note of engine to ensure engine and mower are working efficiently, slow down or stop once engine starts to labour.

FAILURE TO DO THIS WILL RESULT IN CLUTCH SLIP AND ULTIMATELY SEVERE DAMAGE TO THE CLUTCH AND DRIVE BELTS.



When moving from normal working conditions to heavier cutting, it may be evident that the engine dies down and loses revs. SLOW DOWN IMMEDIATELY to allow the engine revs to build up again to normal working speed. Follow the procedure detailed above in "Normal Forward Speed". Expected forward speed will be much lower in heavy conditions.

FAILURE TO DO THIS WILL RESULT IN CLUTCH SLIP AND ULTIMATELY SEVERE DAMAGE TO THE CLUTCH AND DRIVE BELTS.

5.6 STOPPING THE MOWER

When stopping the mower after a period of heavy use. Run the machine at half working speed in a stationary position, for at least 4 minutes, to allow the drive belts to cool down.

1. Show caution to hot parts e.g. engine exhaust, belts etc after engine is switched off.
2. Ensure the mower drawbar has been adjusted to allow the mower to run directly behind the towing vehicle and is not in an offset position
3. When the mower has cooled down (Min 1hr after last used) Ensure all grass has been removed from engine cooling fins, drive belt area, and rotors before operating again.

5.7 TRANSPORT POSITION

When the mower is being moved from one site to another it is advisable to raise the deck to the highest position (Transport position, See section 5.3 "Mower cutting

height”)

The engine must be stopped and the blades at a standstill before adjusting to the transport position.

Remove any crop debris from the deck before leaving the field.

Never move from one site to another with the engine running.

Please note the AT - Flail Mower is not road legal, and should not be used on public roadways

5.8 ANTI-SCALPING ROLLER/SIDE SKIDS

The main purpose of the anti scalping roller is to prevent damage. If a wheel drops into a hole, or there is uneven ground between the wheels, the roller takes the weight of the mower, avoiding the flails scalping the ground; combined with the side skids the mower provides good protection to the rotor.

The anti scalping roller has the added advantage of enabling kerb side grass to be cut with no difficulty, by allowing the wheel to hang over the kerb edge.

The factory pre-set position of the anti scalping roller and side skids are suitable for most situations.

However, if the mover is used in rough conditions or regularly in heavy crops, the roller and side skids should be lowered, to increase the clearance between the flail and the ground when the roller comes into use.

In circumstances where the mower is being used as a “Finishing Mower” and a striped appearance is desired, the roller can be set down using the various hole positions to give the required cutting height, then the wheels can be lifted clear of the ground.

TO ADJUST THE
ROLLER:

Slacken pivot bolt “A” .

Slacken and remove bolt

“B” (Repeat for both ends of the roller)

Select another hole and

Replace bolt “B” . Tighten bolts “A” and “B” .

TO ADJUST THE SIDE SKIDS:

Remove the bolt at the

Front of the skid and the rear of the skid (Shown as “C”) Select new setting, replace the bolts and tighten. Repeat for the opposite skid; always ensure both skids are set to

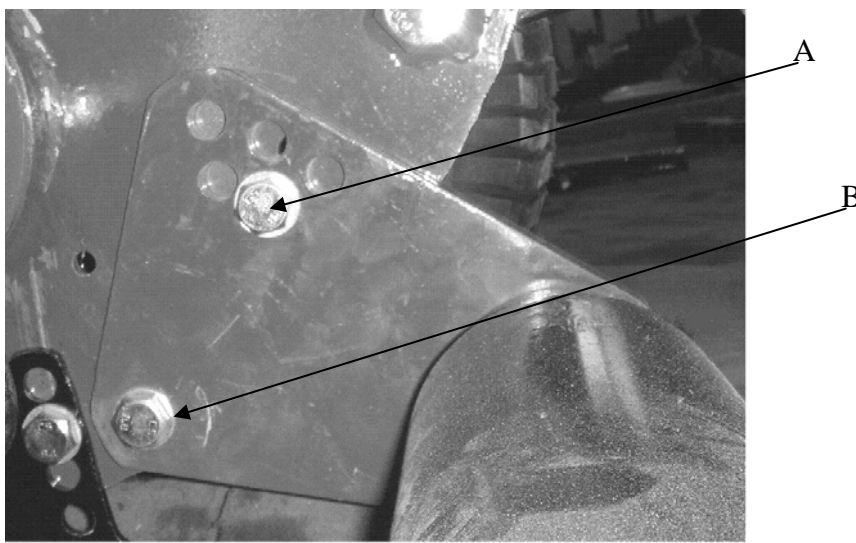

Maintenance Schedule				
Maintenance Operation:	Hourly	Daily	Weekly	Seasonal
Engine (See Engine manufacturers manual)	●	●	●	●
Remove excess crop gathered on deck	●	●	●	●
Remove excess crop wrapped around rotor ends	●	●	●	●
Visual check to ensure nothings loose		●	●	●
Grease Height Adjuster		●	●	●
Grease Rear Roller		●	●	●
Grease Rotor Bearings		●	●	●
Tyre Pressures			●	●
Drive belt inspection			●	●
Rotor Bearing inspection			●	●
Wheel Bearing Inspection			●	●
Oil 50mm coupling			●	●
Swivel hitch Bush Wear			●	●
Check All Fastener's are tight and intact			●	●
Safety Chain Guard inspection			●	●
Safety Decals intact			●	●
Safety Guards Intact			●	●
Check Blade wear / condition				●
Check Metal Fatigue				●
Clutch Wear / Function				●

6.1 ENGINE

Refer to engine manufacturers manual, for servicing and maintenance of the engine.

6.2 EXCESS CROP BUILD UP

Remove all crop deposits from the deck, and engine area. Build up of crop deposits could result in heat build and fires

Disconnect the spark plug lead.

Remove any crop that is wrapped around the end of the rotor (A) or on the underside of the deck. Raise the deck to its max height to assist access to the rotor shaft.

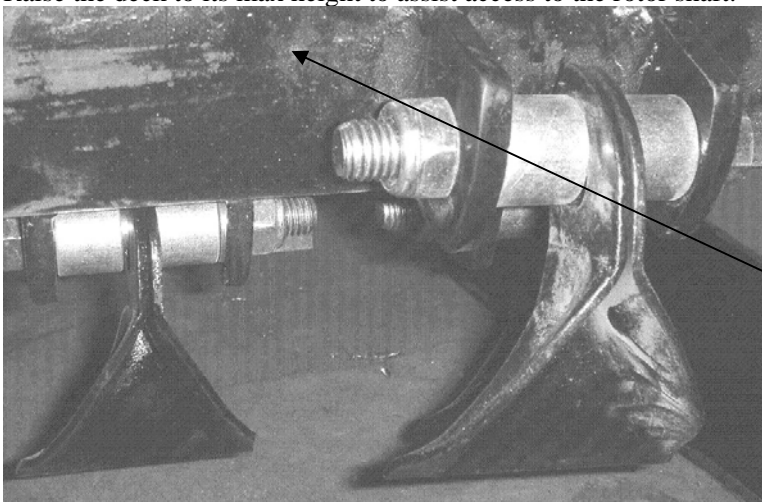

6.3 VISUAL CHECK

Make a visual check around the mower, check for missing / loose parts or damaged / worn components. All faults must be either repaired or replaced.

6.4 TYRE PRESSURES

DO NOT exceed recommended tyre pressures

22×1100 -8	7 – 10 PSI
16.5×6.50 -8	28 PSI (Max)

6.5 ROTOR BEARING INSPECTION

Rotate rotor shaft by hand and feel for any roughness in the bearings. Also try to pull the shaft from side to side to see if any movement is found. If symptoms persist strip down the rotor-housing unit and inspect bearings.

6.6 WHEEL BEARING INSPECTION

Jack one side of the mower body up, so the wheel is just off the ground. Rotate the wheel by hand, and check the wheel alignment. To check the bearings, try to move the wheel from left to right and feel for any play in the bearings (A), ensure the wheel-locating bolt is tight before you start and follow any jacking procedures. If any play is found remove the wheel and inspect bearings. Replace any faulty bearings.

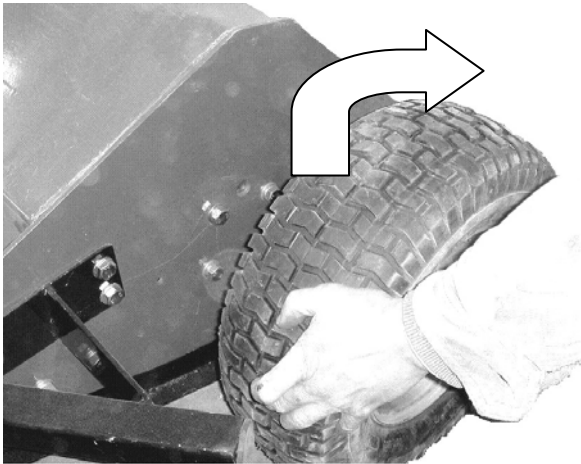

6.7 OIL 50mm COUPLING/BUSH WEAR

Check coupling for signs of damage or wear, swivel the coupling 36. degrees and check that the bushes are not too worn. Replace any worn or damaged parts.

Oil the coupling regularly as shown below.

6.8 GENERAL INSPECTION

Check the mower to ensure all fasteners are tight and all safety guards / chains are intact and fitted securely. Check all safety-warning decals, Replace any defective guards or damaged decals.

6.9 ROTOR FLAIL MAINTENANCE

The AT range has “Rock” knives designed to last a long time. The standard knives are double edged for even longer life. However, when breaking or losing a knife, it is important to replace it immediately. Failure to do this can cause serious unbalancing problems. (Always use spare parts)

At the time of replacement, the opposite knife on the rotor should be checked for wear. If it is partially or well worn then it should be changed to maintain an accurate weight balance.

When the first cutting edge is becoming blunt, the whole set of flails should be turned around. (Using blunt knives will reduce the cutting efficiency and increase fuel consumption).

Replacing or reversing the knives follows this simple procedure:

- (A) Ensure mower engine has stopped and the knives have stopped rotating. Switch of the fuel tap and let the machine cool down for 5 minutes. Remove the spark plug to ensure the engine cannot be started.
- (B) Raise the mower to its max cutting height.
- (C) Carefully raise the drawbar to an incline position, so that the height adjuster

bar at the rear of the mower takes the weight. NB: Do not attempt this with the wheels behind version; raise the front jack to its max height.

(D) Slacken and take out the shackle bolt.

(E) Replace or turn around blades (Note the direction of rotation)

(F) Replace shackle bolt securely, but still allowing the shackle to swing on the fixing bush.

NOTE:

Never use cracked or repaired shackles when replacing knives. If the shackle fixing has become damaged or worn, replace with new parts



For repairs beyond the minor adjustments listed above, contact your local dealer or contact .

ATV Flail Mower Assembly

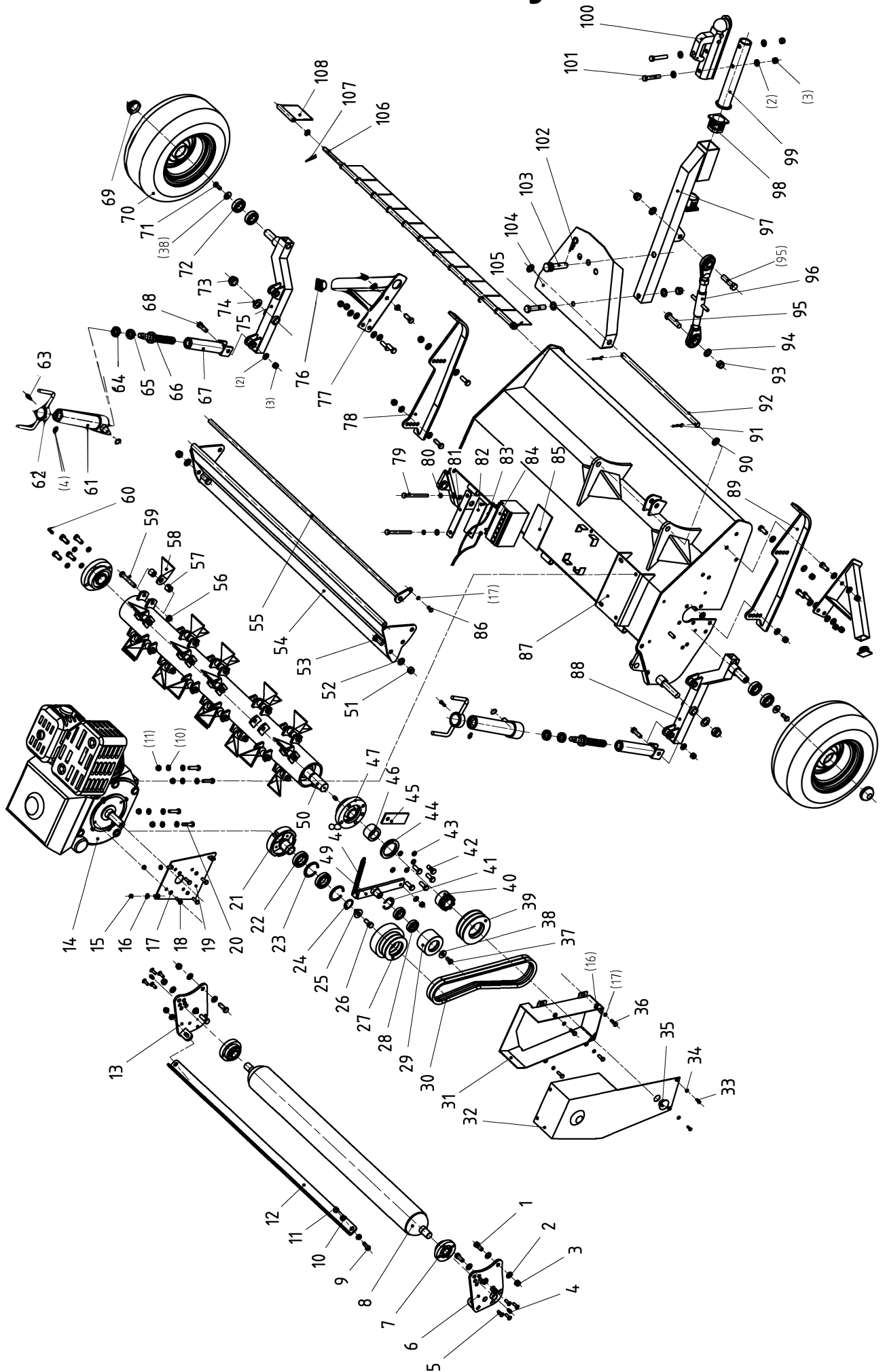

ATV Flail Mower Parts List

Part	Code	Name	Quantity
1	GB5783-86	BOLTS M12 X 35	8
2	GB97.1-85	WASHER 12	49
3	DIN985	LOCK NUT M12	17
4	GB1153-89	OIL CUP	4
5	GB/T 70.3-2008	HEX BOLTS M8 X 25	8
6	VFSH200.017	LEFT ROLLER HANGPLATE	1
7	EF100.00.012	FLANGE BEARING	2
8	VFSH200.018	ROLLER	1
9	GB5783-86	BOLTS M10 X 35	2
10	GB97.1-85	WASHER 10	23
11	DIN985	LOCK NUT M10	11
12	VFSH200.106	SCRAPER	1
13	VFSH200.020	RIGHT ROLLER HANG PLATE	1
14		ENGINE	1
15	GB62-88	NUT M8	2
16	GB97.1-85	WASHER 8	6
17	GB93-87	WASHER 8	4
18		BOLTS 3/16	4
19	AT120.016A	CONNECT PLATE	1
20	GB5783-86	BOLTS M10 X 45	4
21	MFP120.00.017	CLUTCH	1
22	GB279-88	BEARING 6007ZZ	2
23	GB893.1-86	CIRCLE 62	2
24	GB894.1-85	CIRCLE 35	1
25	AT120.110	WASHER	1
26	AT120.109	BOLTS	1
27	AT120.108	PULLEY	1
28	GB279-88	BEARING 180105	2
29	ATV120.153	TENSION PULLEY	1
30	GB/T1154-97	BELTS B1067	2
31	AT120.018A	PULLEY COVER WELDMENT	1
32	AT120.011A	PULLEY COVER	1
33	GB97.1-85	WASHER 6	2
34	DIN316	BOLTS M16 X 16	2
35	EF100.00.119	RUBBER COVER	1
36	GB5783-86	BOLTS M8 X 25	8
37	GB5783-86	BOLTS M10 X 20	1
38	GB96-85	WASHER 10	3
39	AT120.111	PULLEY	1
40	JB/T7934 Z3	REACH	1
41	GB893.1-86	CIRCLE 47	1
42	GB5783-86	BOLTS M12 X 30	15

ATV Flail Mower Parts List

Part	Code	Name	Quantity
43	GB93-87	WASHER 12	10
44	GB13871-94	OIL SEAL B55 X 80 X 8	1
45	VFSH200.105	FLAP	1
46	AT120.112	OIL SLEEVE	1
47	UC207	BEARING IC207	2
48	AT120.101	SPRING	1
49	AT120.025	SUPPORT WELDMENT	1
50	AT120.019	BLADE ROTOR	1
51	DIN985	LOCK NUT M14	4
52	GB97.1-85	WASHER 14	4
53	GB5783-86	BOLTS M14 X 35	2
54	VFLAH125.012	REAR COVER WELDMENT	1
55	VMA200.016	HANGING PIPE	1
56	DIN985	LOCK NUT M12 X 1.5	28
57	FCN120.113	SPACER	56
58	FCN120.110	BLADE	28
59	GB5782-86	BOLTS M12 X 1.5 X 78	28
60	GB1153-89	OIL CUP M8 X 1	2
61	MFP120.00.038-B	OUTER SLEEVE WELDMENT	2
62	MFP120.00.039B	HANDLE WELDMENT	2
63	GB 70-85	HEX BOLTS M8 X 30	2
64	GB 276-94	BEARING 61904	2
65	GB 301-95	BEARING 51104	2
66	TR200.00.120B	LIFT SCREW	2
67	MFP120.00.037-B	INNER FORK WELDMENT	2
68	GB5782-86	BOLTS M12 X 60	2
69		DUST CAP 52	2
70		TYRE 16.5 X 6.5-8	2
71	GB5783-86	BOLTS M10 X 25	2
72	GB/T278-94	BEARING 80205	4
73	DIN985	LOCK NUT M20	2
74	GB97.1-85	WASHER 20	2
75	AT120.021A	TYRE SUPPORT WELDMENT	2
76	MFP120.00.101	BIG COVER	6
77	AT120.020	PROTECT BRACKET	2
78	RMC200.013	LEFT FOUNDATION	1
79	GB5782-86	BOLTS M10 X 120	2
80	GB93-87	WASHER 10	4
81	AT120.107	PRESSING PLATE	1
82	AT120.106	RUBBER PLATE 150 X 50	1
83	AT120.010	BATTERY WIRE	2
84		BATTERY	1

ATV Flail Mower Parts List

Part	Code	Name	Quantity
85	AT120.105	RUBBER PLATE 150 X 90	1
86	GB5783-86	BOLTS M8 X 30	1
87	AT120.012A	COVER DECK WELDMENT	1
88	AT120.021A-1	TYRE SUPPORT WELDMENT	2
89	RMC200.012	LEFT FOUNDATION	1
90	GB97.1-85	WASHER 18	2
91	GB91-86	PIN 5 X 32	2
92	AT120.102	AXIS OF TRACTION	1
93	DIN985	LOCK NUT M16	3
94	GB97.1-85	WASHER 16	6
95	GB5782-86	BOLTS M16 X 65	2
96		LIFT LINK ASSEMBLY	1
97	AT120.014	PULL PIPE	1
98	AT120.104	SHAFT SLEEVE	2
99	AT120.015	AXIS OF TRACTION COVER	1
100	GM8610	TRAILER COVER	1
101	GB5782-86	BOLTS M12 X 70	3
102		R PIN	1
103	AT120.103	PIN	1
104	AT120.013	HITCH FRAME	1
105	GB5782-86	BOLTS M6 X 80	1
106	RMC200.102	FENDER PIPE	1
107	GB91-86	PIN	2
108	VFSH200.103	FENDER	12